

TECHNICAL
INFORMATION

TECHNICAL INFORMATION

Features

Wiring Diagram

Circuit Diagram

Switch

- 10AX, 250V~
- 1 Pole, 1 Line
- With screw or screwless options

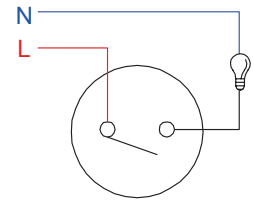
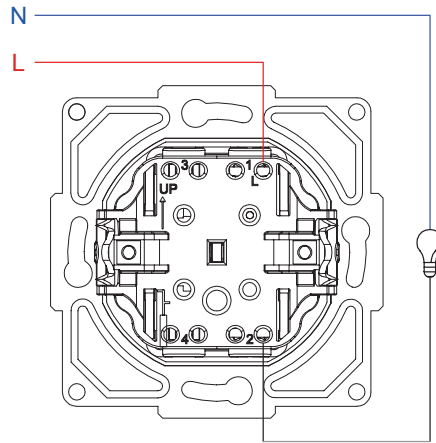

Illuminated Switch

- 10AX, 250V~
- 1 Pole, backlit, 1 Line
- With screw or screwless options

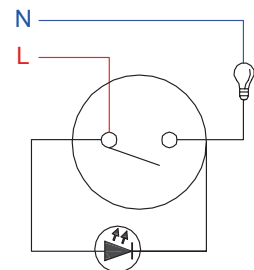
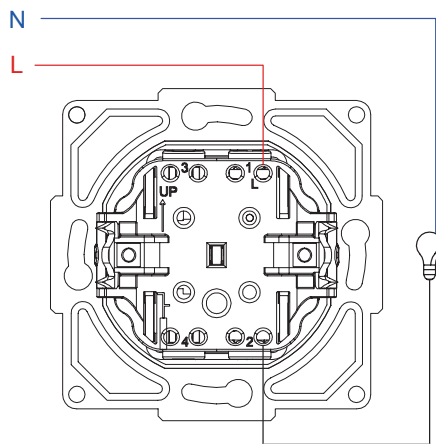

2 Gang Switch

- 10AX, 250V~
- 1 Pole, 2 Lines
- With screw or screwless options

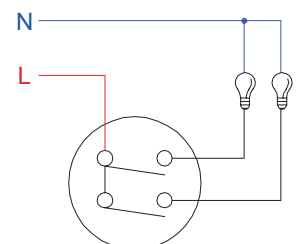
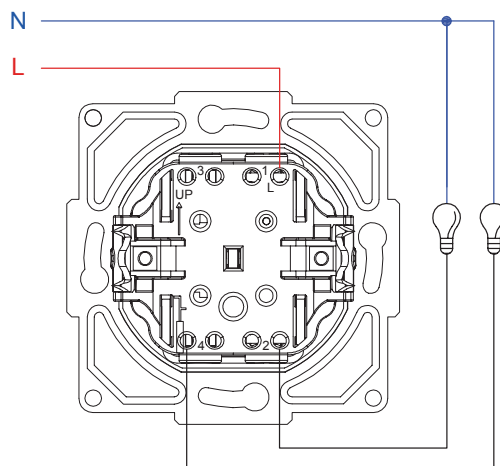

TECHNICAL INFORMATION

Features

Wiring Diagram

Circuit Diagram

Illuminated 2 Gang Switch

- 10AX, 250V~
- 1 Pole, backlit, 2 Lines
- With screw or screwless options

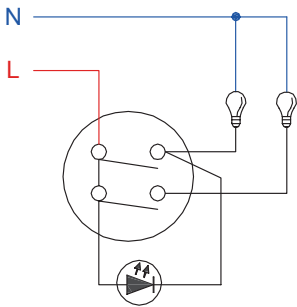
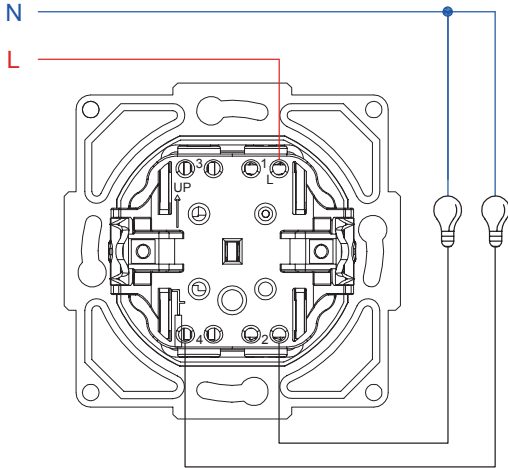

Push Button

- 10A, 250V~
- 1 Pole, 1 Line
- Push Button
- With screw or screwless options

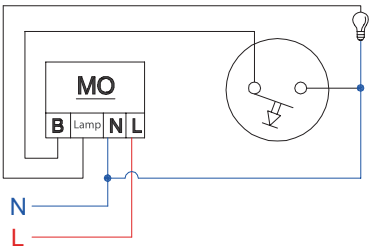
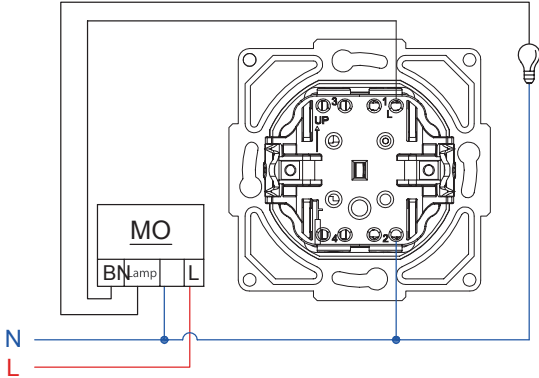

Illuminated Push Button

- 10A, 250V~
- 1 Pole, backlit, 1 Line
- Push Button
- With screw or screwless options

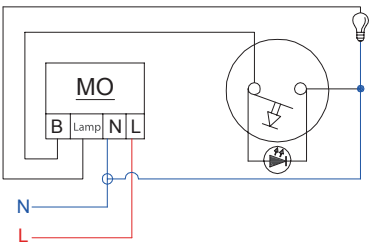
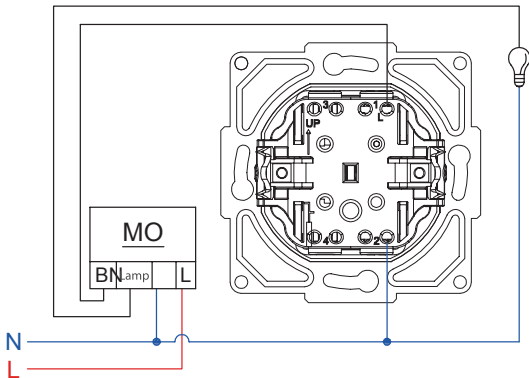

TECHNICAL INFORMATION

Features

Wiring Diagram

Circuit Diagram

2 Way Switch

- 10AX, 250V~
- 1 Pole, 2 Lines
- With screw or screwless options

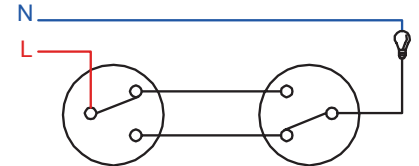
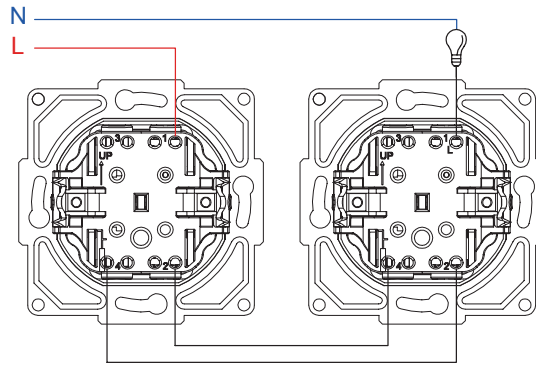

Illuminated 2 Way Switch

- 10AX, 250V~
- 1 Pole, backlit, 2 Lines
- With screw or screwless options

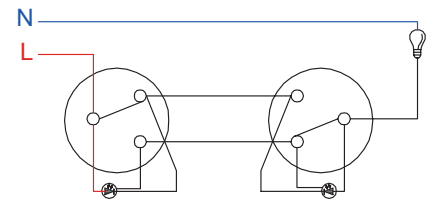
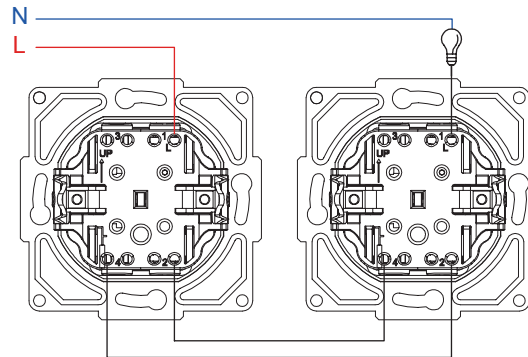

Intermediate Switch

- 10AX, 250V~
- 1 Pole, 2 Lines
- With screw or screwless options

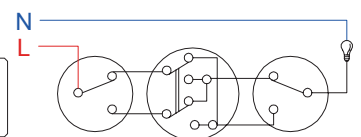
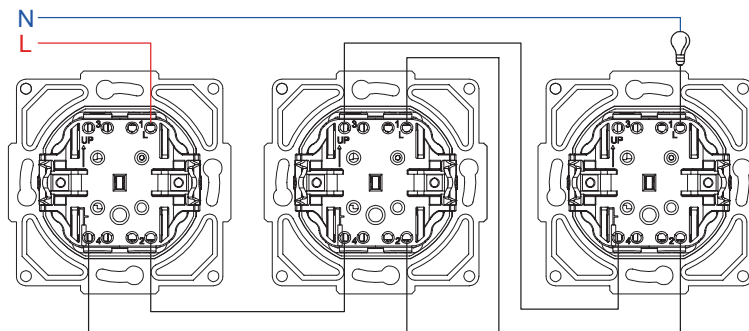

TECHNICAL INFORMATION

Features

Wiring Diagram

Circuit Diagram

3 Gang Switch

- 10AX, 250V~
- 1 Pole, 3 Lines
- With screw

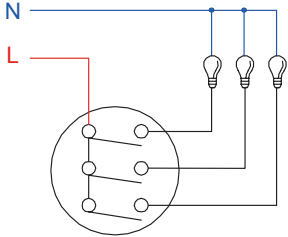
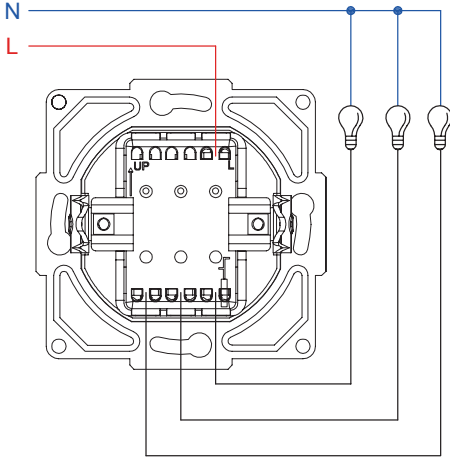

Roller Blind Switch

- 10AX, 250V~
- 1 Pole, 2 Lines
- With screw

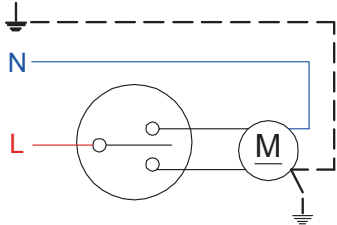
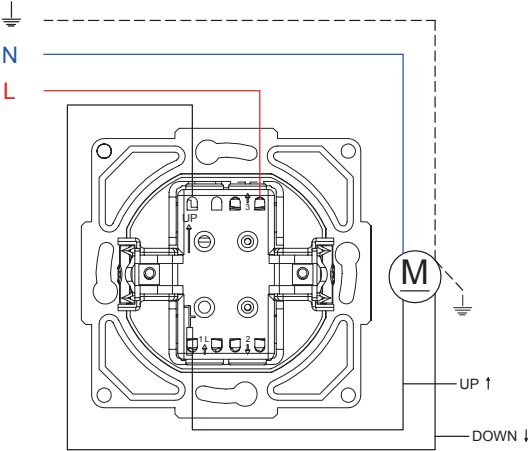

Socket

- 16A, 250V~
- 2 Poles
- With screw

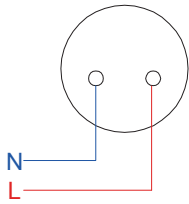
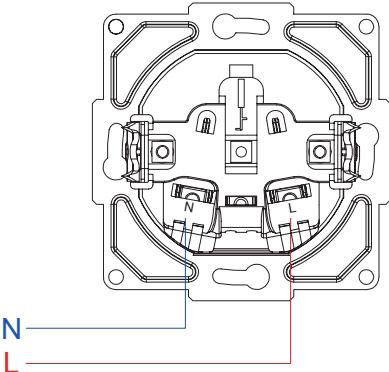

TECHNICAL INFORMATION

Features

Wiring Diagram

Circuit Diagram

Socket with Side Earth

- 16A, 250V~
- 2 Poles, with side earth
- With screw or screwless options

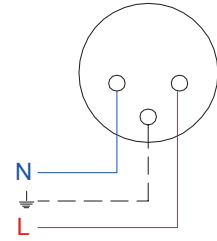
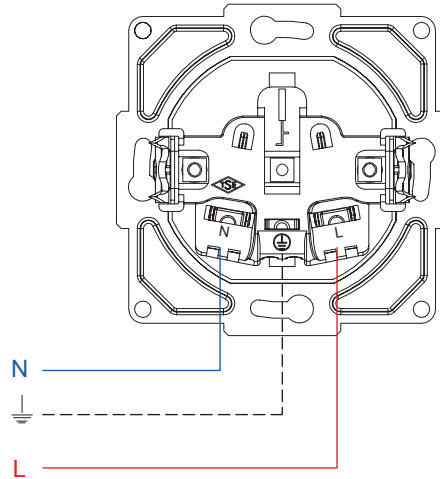

Socket with Pin Earth

- 16A, 250V~
- 2 Poles, Ups
- With screw or screwless options

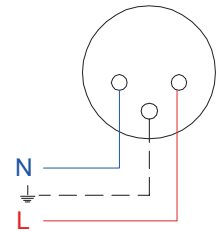
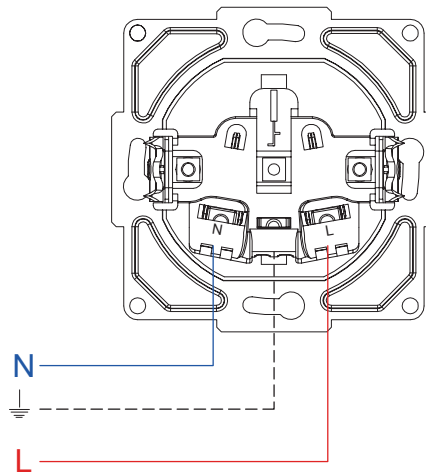

Double Socket with Side Earth

- 16A, 250V~
- 2 Poles, with side earth
- With screw

